

ERGOHUMANULTRA



ANTARES 
INTERNATIONAL



ERGOHUMAN
ULTRA



**THE WORLD MOST
COMPETITIVE MESH CHAIR**

ERGOHUMAN ULTRA

CUTTING-EDGE DESIGNS >>



6D ADJUSTABLE
AUTOMATIC LUMBAR
SUPPORT

FPC
HIGH-TECH
POLYMERIC
MATERIAL

MESH SUPPORT
12 ZONE INDIVIDUAL
ELASTOMER

4D ARMREST

EAGLE MAIN
CONTROL SYSTEM



ERGOHUMAN ULTRA

INNOVATION TO UPGRADE >>

EAGLE MECHANISM

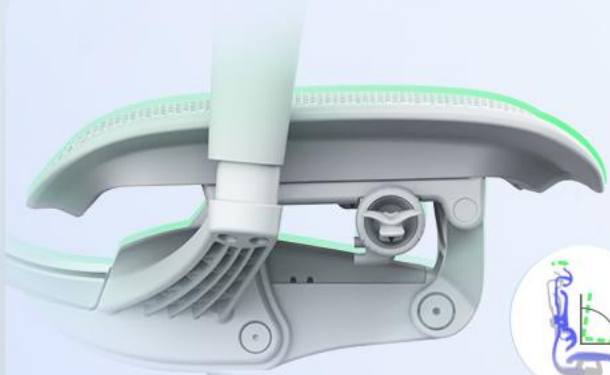

FORWARD TILT



RECLINE



TENSION ADJUSTMENT



SEAT DEPTH

EAGLE MAIN CONTROL SYSTEM

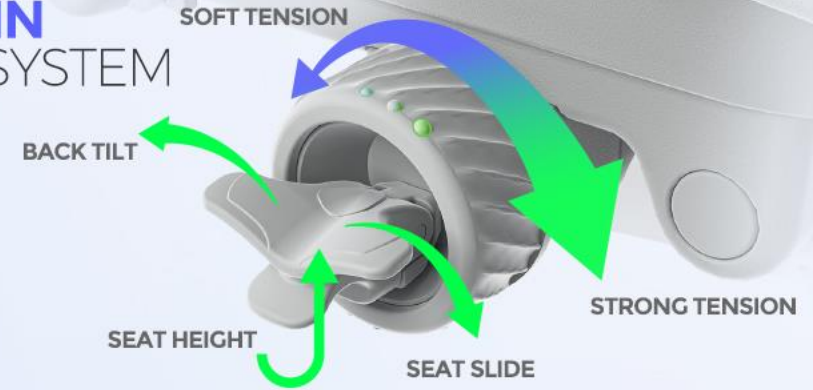

4D ARMREST



HEIGHT



DEPTH



WIDTH



ANGLE

BIONIC LUMBAR & BACK SEPARATION

6D ADJUSTABLE AUTOMATIC LUMBAR SUPPORT



WAIST TRACKING



LEFT & RIGHT MOVEMENT



LARGE SCALE



TENSION ADJUSTABLE

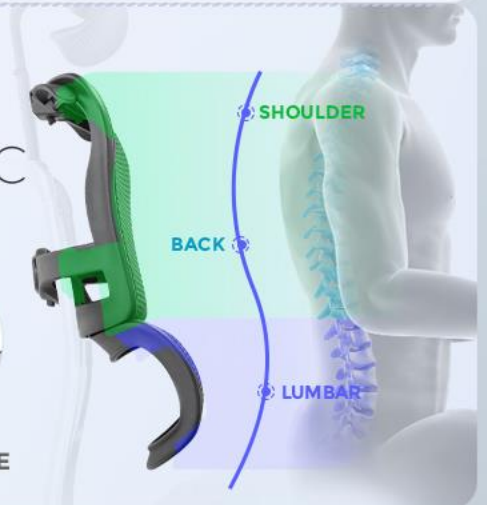

ERGOHUMAN ULTRA

DRIFT AND STRESS-RELEASE » EAGLE MECHANISM

- 1/ **NECK SUPPORT** UNCHANGED
- 2/ **LUMBAR SUPPORT** UNCHANGED
- 3/ **FEET FLAT ON FLOOR**
LEG NOT PRESSED
- 4/ **EASY TO RECLINE**
EASY TO GET UP

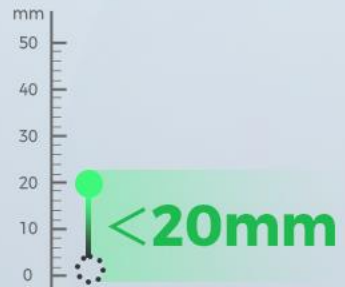

NECK SUPPORT
UNCHANGED

LEG NOT PRESSED

FEET FLAT ON FLOOR

WAIST SUPPORTED

ERGOHUMAN ULTRA

NEW GENERATION

EAGLE MAIN CONTROL SYSTEM >>

- **SEAT HEIGHT, SEAT DEPTH, RECLINE, AND TENSION ADJUSTMENT**

COMFORT PATENTED PREMIUM DESIGN, ACHIEVE THE SEAT HEIGHT, SEAT SLIDE, RECLINE AND TENSION ADJUSTMENT TO BE OPERATED IN ONE POSITION

- **TACTILE IDENTIFICATION SYSTEM**

UNIQUE TACTILE DOTS DESIGN, EASILY IDENTIFY AND ADJUST THE RECLINE TENSION WITHOUT LAY DOWN TO SEE THE LEVER

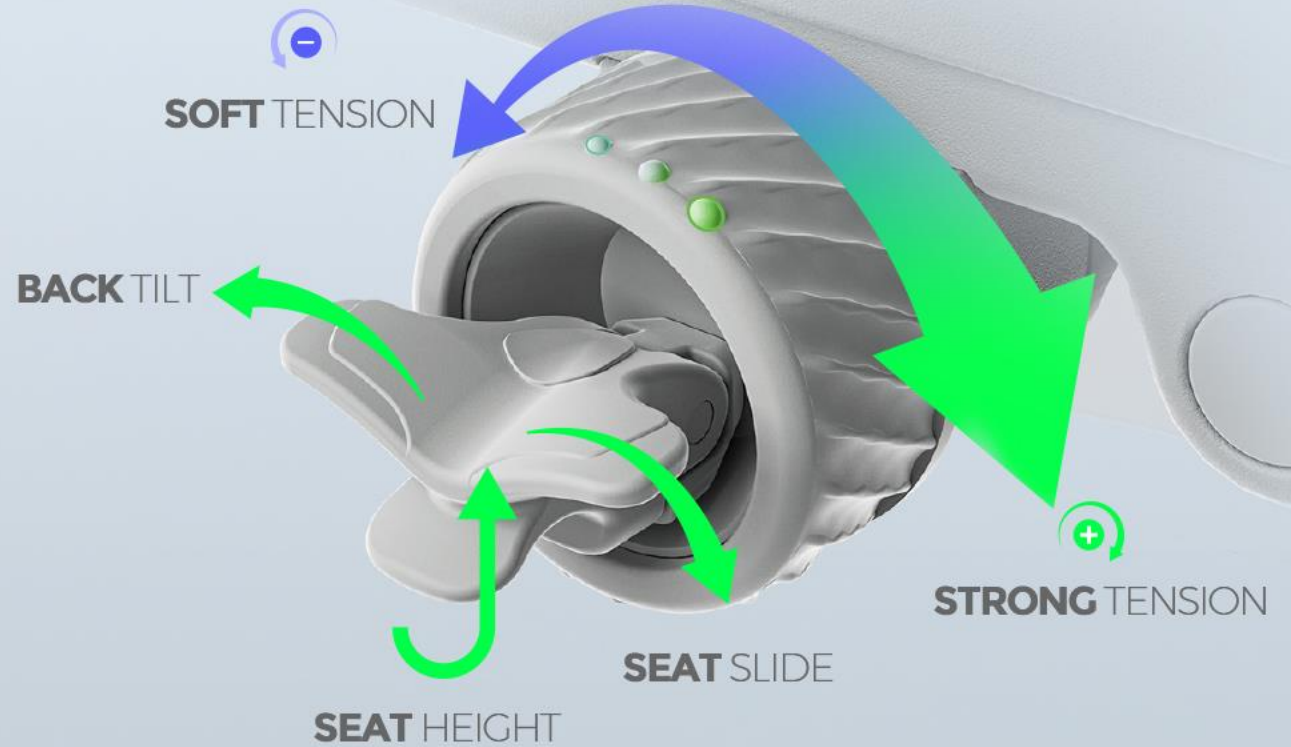

ERGOHUMAN ULTRA BIONIC LUMBAR

& BACK SEPARATION DESIGN »

- 1/ MAINTAIN NATURAL **S-SHAPE CURVE OF SPINE**
- 2/ **6 LOCKING** POSITIONS FOR PROPER POSTURE
- 3/ **MEET DIVERSE** NEED OF DIFFERENT USER

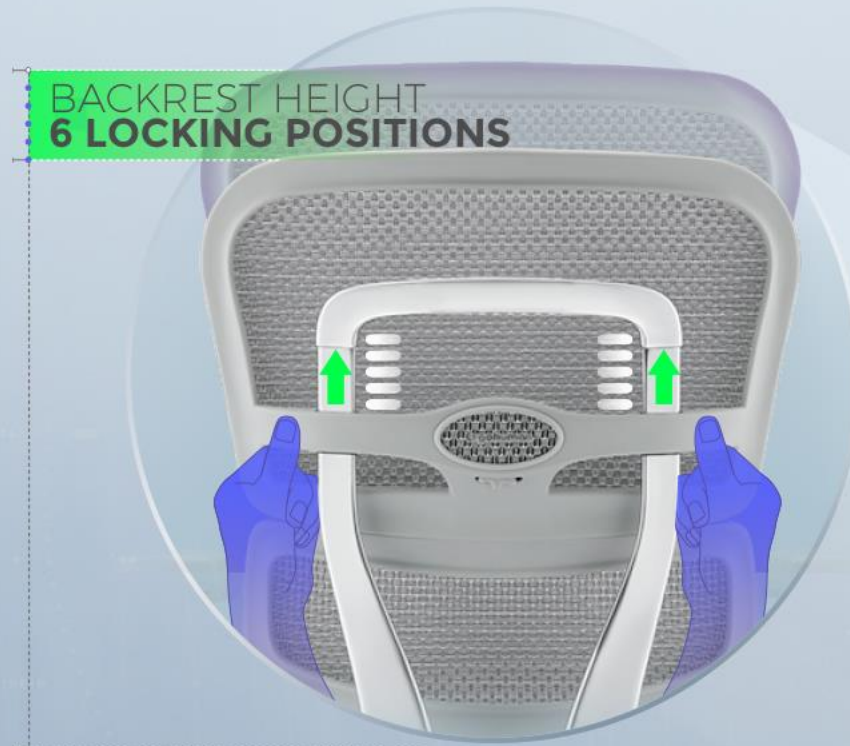

SHOULDER

BACK

LUMBAR



ERGOHUMAN ULTRA

6D AUTOMATIC LUMBAR SUPPORT >>

- LARGE CURVED LUMBAR SUPPORT TO FIT VARIOUS SITTING POSTURE AND MEET DIVERSE NEED OF DIFFERENT USERS



UP & DOWN

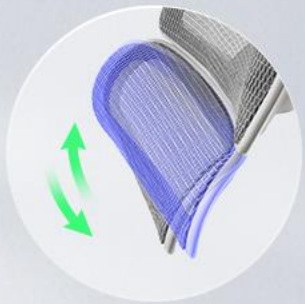

LEFT & RIGHT



FORWARD & BACKWARD



UP & DOWN

LEFT & RIGHT

ERGOHUMAN ULTRA

12 ZONE INDIVIDUAL ELASTOMER MESH SUPPORT »

LUMBAR SUPPORT TENSION AUTOMATICALLY ADJUST, AND CAN INCREASE OR DECREASE THE SUPPORT TENSION BY 40% MANUALLY ADJUSTING THE KNOB, SHAPING A MORE COMFORTABLE NATURAL SUPPORT FOR THE LUMBAR VERTEBRA.

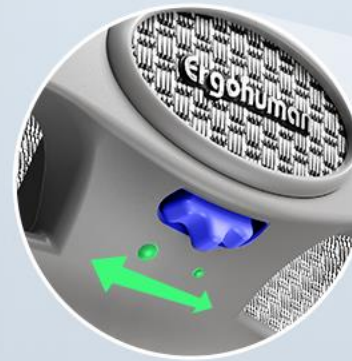

TACTILE IDENTIFICATION KNOB
+40% LUMBAR SUPPORT TENSION



WAIST TRACKING

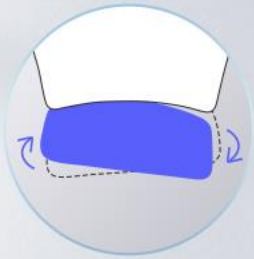

**LEFT & RIGHT
MOVEMENT**

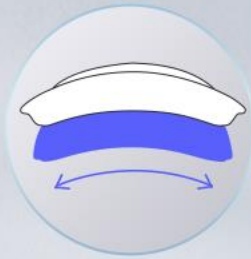

LARGE SCALE



**TENSION
ADJUSTABLE**

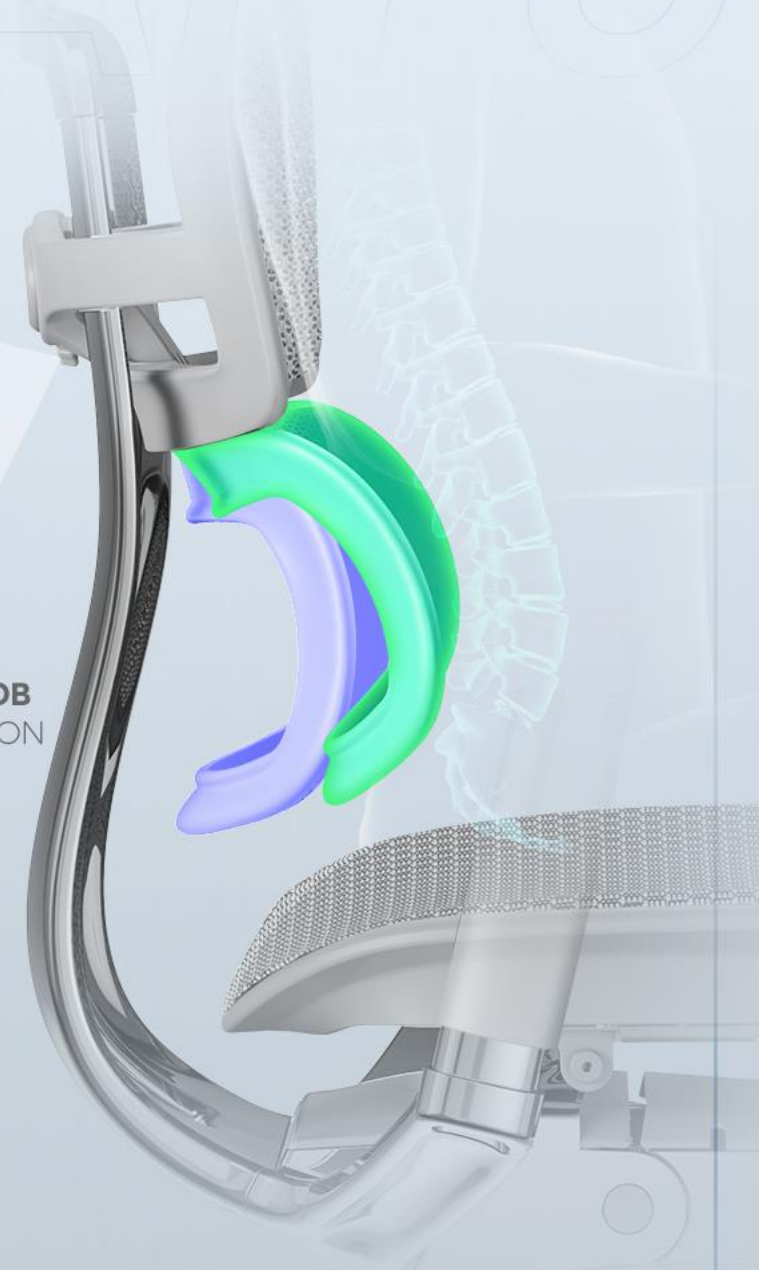

ERGOHUMAN ULTRA

12 ZONE INDIVIDUAL ELASTOMER MESH SUPPORT »

- 1/ NEW HIGH-TECH MESH
- 2/ DIVEDED INTO 12 ZONES OF DIFFERENT TENSION
- 3/ EFFECTIVE RELEASE OF SEDENTARY STRESS

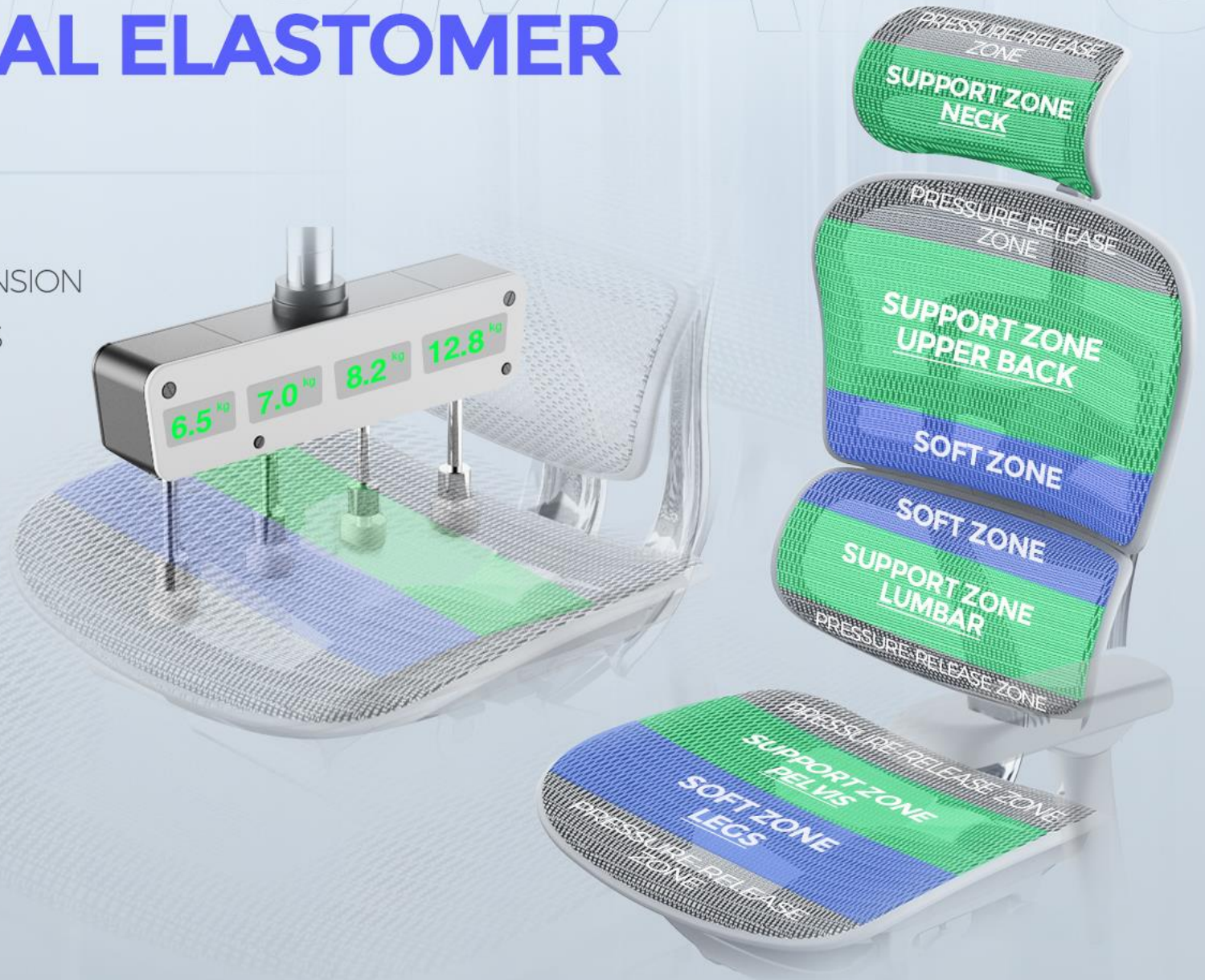

ERGOHUMAN ULTRA

SEAT DEPTH ADJUSTMENT »

- 1/ SEAT DEPTH ADJUSTABLE RANGE 50 MM
- 2/ FULL SUPPORT FOR LEGS, AVOID LEG DISCOMFORT

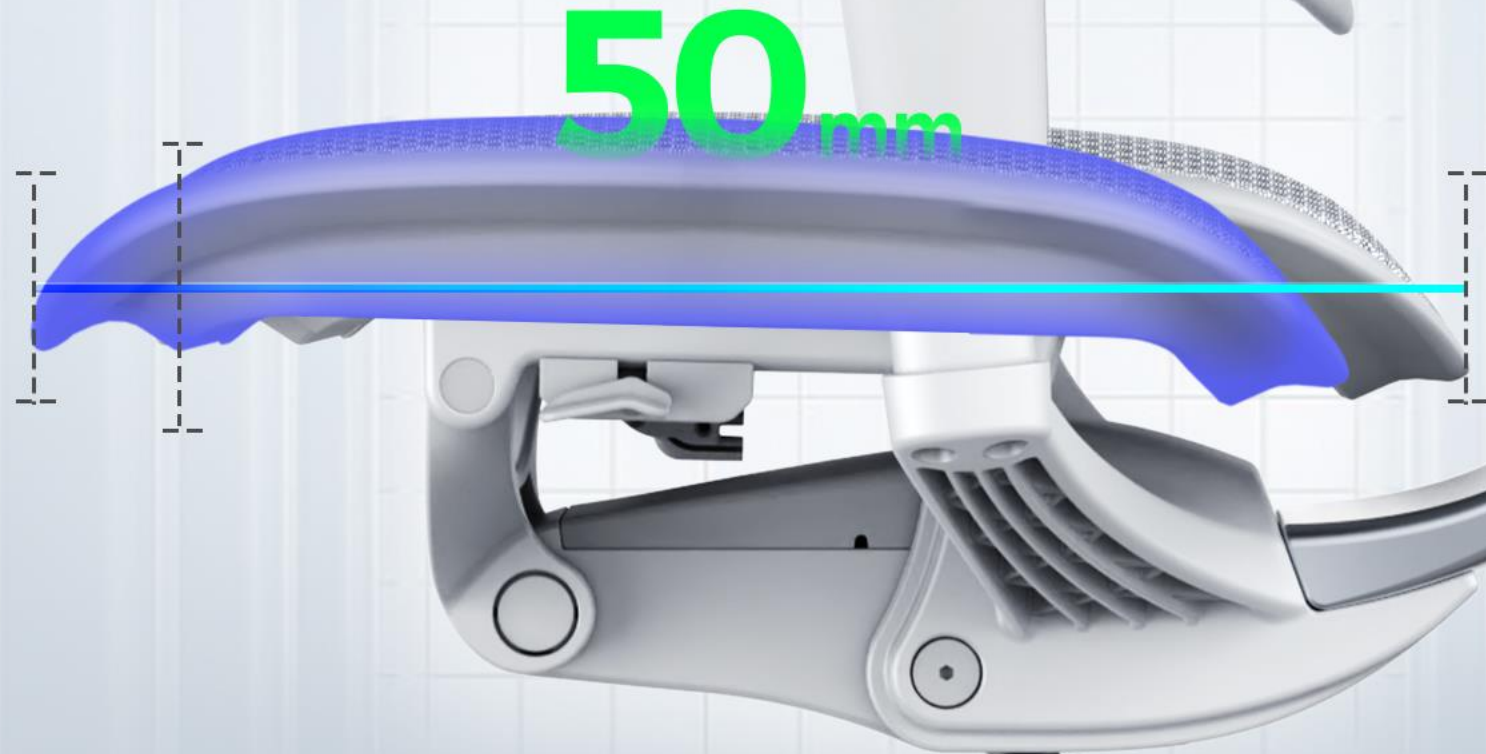

ERGOHUMAN ULTRA

FORWARD SEAT ANGLE SEAT BACK & CUSHION »

- NOT EASY TO GET TIRED, HELPING TO DISPERSE THE PRESSURE ON THE SPINE
- MAINTAIN HEALTHY DESK WORK POSTURE



ERGOHUMAN ULTRA

5D⁺ ARMREST (OPTIONAL) »

1/ LARGE ARMPADS WITH SUPER SOFT TOUCH, FRIENDLY FOR ARMS

2/ INTERGRATED WITH HEIGHT, DEPTH, WIDTH, ANGLE, FRONT-END TILT-UP AND SYNCHRO TILT FUCTION



HEIGHT



DEPTH



WIDTH



ANGLE

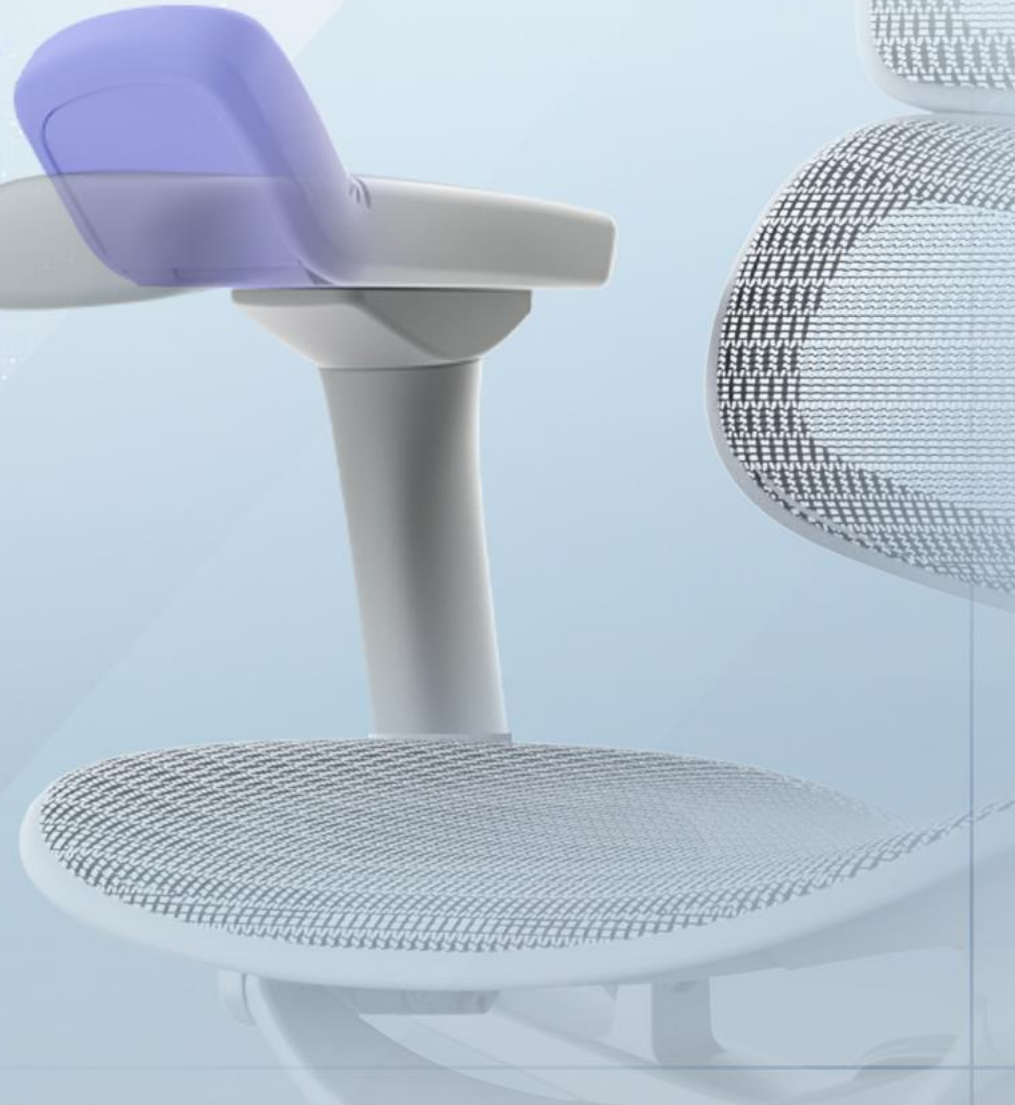

ERGOHUMAN ULTRA

ARMREST SYNCHRO TILT DESIGN »

STABLE DYNAMIC SUPPORT FOR ARM,
RELEASING PRESSURE ON THE SHOULDER WHEN USER RECLINE



ERGOHUMAN ULTRA

2D HEADREST »

325mm

- DEEPLY FIT TO THE NECK, RELEASING CERVICAL PRESSURE

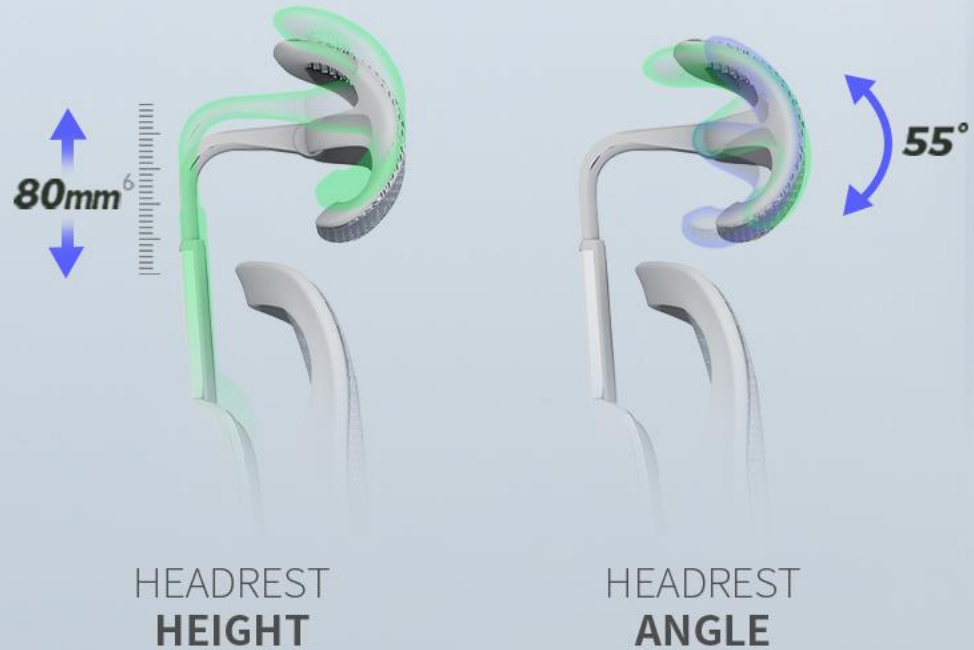

ERGOHUMAN ULTRA

TOP OF CLASS ACCESSORIES >>

ENHANCED-COMFORT FOOTREST

UPGRADED COMFORT,
CAUSE NO PRESSURE ON LEGS

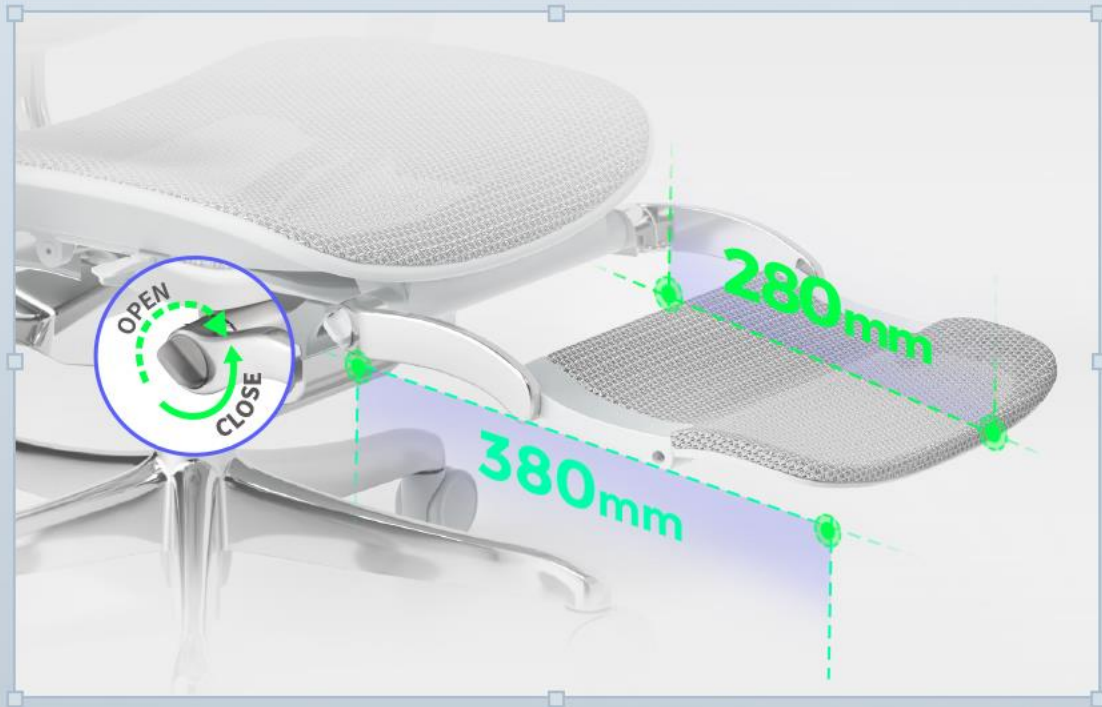

STEALTH COAT HANGER

ONE CLICK TO STORAGE, ROUNDED ARC DESIGN TO
PREVENT SCRATCHING CLOTHING



ERGOHUMAN ULTRA

FPC HIGH-TECH MATERIAL

(FUNCTIONAL POLYMERIC COMPOSITE) >>

LIGHTER, FIRMER, MORE ECO-FRIENDLY,
AND WITH HIGHER QUALITY SURFACE



FIRMER

LIGHTER



**REDUCE INDOOR AIR POLLUTION
AND THE RISK OF CHEMICAL EXPOSURE**

HIGHER QUALITY SURFACE



ERGOHUMAN ULTRA

APPLICABLE SCENE >>



ERGOHUMAN ULTRA

DIMENSIONS & OPTIONS >>



FRAME OPTIONS

SPACE GRAY FRAME



BLACK FRAME



T168 MESH



BLACK



NATURAL



SCARLET



COBALT



PINK



GREEN

W09 MESH



BLACK



WHITE



GREY



BLUE

ANTARES 
INTERNATIONAL

ERGOHUMAN *ULTRA*

SHOCK AND AWE

