

**MORK**



# MORK

*“**Mork**, you were able to  
ruin my life in just one night”*

---

Mindy McConnell



*design: Orlandini Design*





**MORK KIT 221/F**

Scocca su base piramidale  
in alluminio con piedini,  
supporto medio, girevole 360°.

*Shell on pyramidal  
aluminium base with glides,  
medium seat support, 360°  
swivel.*



**MORK KIT 221/G**

Scocca su base 4 razze piccola  
in alluminio con piedini,  
supporto alto, girevole 360°.

*Shell on 4 stars small  
aluminium base with glides,  
high seat support, 360°  
swivel.*

## MORK kit 221/A

Sedia in plastica 4 gambe / 4 legs plastic chair

### 01. 1x TLF141\*\*

Telaio 4 gambe, senza piedini. 4 legs frame, without glides.

### 02. 4x PDY003ANR

Piedino nero autolivellante. Black self-levelling glide.

### 03. 1x MSP054A\*\*

Scocca. Shell.

### 04. 2x ACY287\*\*

Clip posteriore per fissaggio scocca su telaio. Rear hook for shell fixing on frame.

### 05. 1x CFP010A\*\*

Confezione bottone. Button kit.

### 06. 1x VTM0512BPXFB

Vite HILO s/punta testa Ø 10,5 TB + DS 5x12mm, brunita. HILO screw tip Ø 10,5 truss head 5x12mm, bronzed.

### Opzioni carter / Carter options

#### 1x ACP301\*\*B

Carter sottoscocca per telaio 4 gambe. Outer seat cover for 4 legs frame.

#### 4x VTM0513BPCNR

Vite HILO testa Ø 10,5mm TB + DS 5x13mm, nera. HILO screw tip Ø 10,5 truss head 5x13mm, black.

### Opzioni pannello sedile / Seat panel options

#### 1x COL009A06

Pannello sedile in legno da tappezzare. Wooden seat panel to be upholstered.

#### 6x VTM0514BPBFZ

Vite TBEI M5x14mm, zincata. Screw hex recess truss head M5x14mm, zinc-plated.

### Opzioni pannello scocca / Panel options

#### 1x COP010A07

Pannello scocca in plastica da tappezzare. Plastic shell panel to be upholstered.

#### 6x VTM0514BPBFZ

Vite TBEI M5x14mm, zincata. Screw hex recess truss head M5x14mm, zinc-plated.

#### 1x VTM0525BPBFB

Vite TBEI M5x25 mm, brunita. Screw hex recess truss head M5x25mm, bronzed.

#### 4x ACT321NR

Velcro per fissaggio copertina integrale tappezzata. Velcro strap to fix upholstery shell.

### Opzioni / Options

#### 4x PDT003

Feltro nero per piedino autolivellante. Black felt for self-levelling glide.



### Colori / Colours

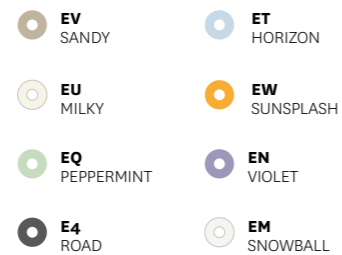

### Colori carter / Carter colours

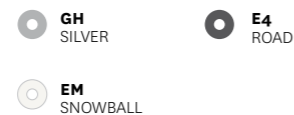

### Colori bottone / Button colours

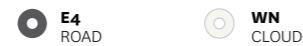

### Colori telaio / Frame colours

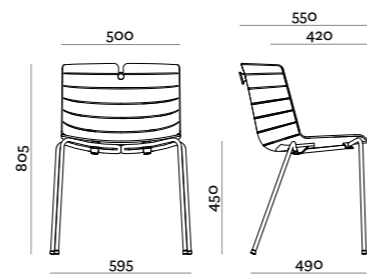
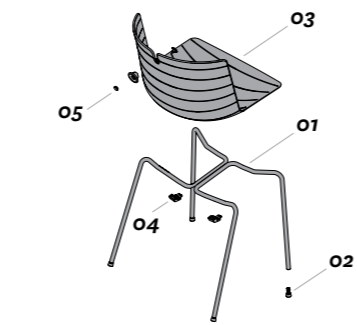
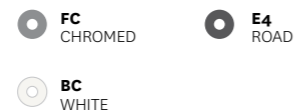

## MORK kit 221/C

Sedia in plastica su slitta / Skid plastic chair

### 01. 1x TLF142\*\*

Telaio a slitta. Skid frame.

### 02. 4x PDA001ANE

Piedino neutro antirotazione per telaio a slitta. Neutral anti-rotation glide for skid frame.

### 03. 1x MSP054A\*\*

Scocca. Shell.

### 04. 2x ACY287\*\*

Clip posteriore per fissaggio scocca su telaio. Rear hook for shell fixing on frame.

### 05. 4x ACP286E4

Riduzione per telaio a slitta. Spacer for skid frame.

### 06. 1x CFP010A\*\*

Confezione bottone. Button kit.

### 07. 1x VTM0512BPXFB

Vite HILO s/punta testa Ø 10,5 TB + DS 5x12mm, brunita. HILO screw tip Ø 10,5 truss head 5x12mm, bronzed.

### Opzioni carter / Carter options

#### 1x ACP301\*\*A

Carter sottoscocca per telaio a slitta. Outer seat cover for skid frame.

#### 4x VTM0513BPCNR

Vite HILO testa Ø 10,5 TB + DS 5x13mm, nera. HILO screw tip Ø 10,5 truss head 5x13mm, black.

### Opzioni pannello sedile / Seat panel options

#### 1x COL009A06

Pannello sedile in legno da tappezzare. Wooden seat panel to be upholstered.

#### 6x VTM0514BPBFZ

Vite TBEI M5x14mm, zincata. Screw hex recess truss head M5x14mm, zinc-plated.

### Opzioni pannello scocca / Panel options

#### 1x COP010A07

Pannello scocca in plastica da tappezzare. Plastic shell panel to be upholstered.

#### 6x VTM0514BPBFZ

Vite TBEI M5x14mm, zincata. Screw hex recess truss head M5x14mm, zinc-plated.

#### 1x VTM0525BPBFB

Vite TBEI M5x25 mm, brunita. Screw hex recess truss head M5x25mm, bronzed.

#### 4x ACT321NR

Velcro per fissaggio copertina integrale tappezzata. Velcro strap to fix upholstery shell.



### Colori / Colours

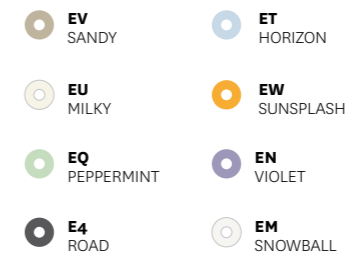

### Colori carter / Carter colours

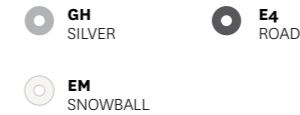

### Colori bottone / Button colours



### Colori telaio / Frame colours

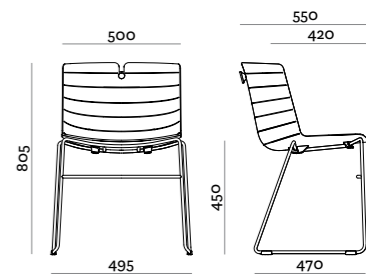
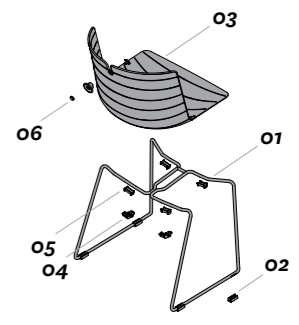
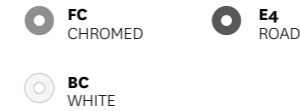

## MORK kit 221/F

Sedia girevole in plastica su base piramidale / Swivel plastic chair on pyramidal base

### 01. 1x BAM07501AL

Base piramidale 4 razze, alluminio. 4 stars aluminium pyramidal base.

### 02. 4x PDY006AGH

Piedino grigio. Grey glide.

### 03. 1x ACM267FZB\* \*\*

Adattatore girevole 360° per base piramidale (con una spina). 360° swivel adaptor for pyramidal base (with one plug).

### 04. 1x ACY299GH\*

Tappo sottobase grigio per adattatore fisso e girevole. Swivel and fixed adaptor lower cap, grey.

### 05. 1x PSM14013AL

Supporto in alluminio medio con agganci automatici. Aluminium medium seat support with automatic hooks.

### 06. 1x MSP054A\*\*

Scocca. Shell.

### 07. 2x ACY287\*\*

Clip posteriore per fissaggio scocca su telaio. Rear hook for shell fixing on frame.

### 08. 1x CFP010A\*\*

Confezione bottone. Button kit.

### 09. 1x VTM0512BPXFB

Vite HILO s/punta testa Ø 10,5 TB + DS 5x12mm, brunita. HILO screw tip Ø 10,5 truss head 5x12mm, bronzed.

### 10. 1x VTM0620PSBFZ\*

Vite TPSEI M6x20mm, zincata. Screw bevelled hex recess flat head M6x20mm zinc-plated.

#### Opzioni pannello sedile / Seat panel options

##### 1x COL009A06

Pannello sedile in legno da tappezzare. Wooden seat panel to be upholstered.

##### 6x VTM0514BPBFZ

Vite TBEI M5x14mm, zincata. Screw hex recess truss head M5x14mm, zinc-plated.

#### Opzioni pannello scocca / Shell panel options

##### 1x COP010A07

Pannello scocca in plastica da tappezzare. Plastic shell panel to be upholstered.

##### 6x VTM0514BPBFZ

Vite TBEI M5x14mm, zincata. Screw hex recess truss head M5x14mm, zinc-plated.

##### 1x VTM0525BPBFB

Vite TBEI M5x25 mm, brunita. Screw hex recess truss head M5x25mm, bronzed.

##### 4x ACT321NR

Velcro per fissaggio copertina integrale tappezzata. Velcro strap to fix upholstery shell.

#### Opzioni movimento autoallineante Auto-return adaptor options

##### \* 1x ACM267FZA

Adattatore autoallineante per base piramidale. Auto-return adaptor for pyramidal base.

##### \* 1x ACY268GH

Cuffia sottobase grigia per adattatore autoallineante. Cover for auto-return adaptor, grey.

##### \* 1x VTM0610PSBFZ

Vite TPSEI M6x10mm per ACY268GH, zincata. Screw bevelled hex recess flat head M6x10mm for ACY268GH, zinc-plated.



#### Colori / Colours



EV SANDY



ET HORIZON



EU MILKY



EW SUNSPASH



EQ PEPPERMINT



EN VIOLET



E4 ROAD



EM SNOWBALL

#### Colori bottone / Button colours

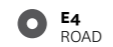

E4 ROAD



WN CLOUD



GJ BLAST BLUE

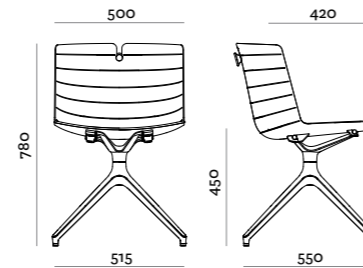
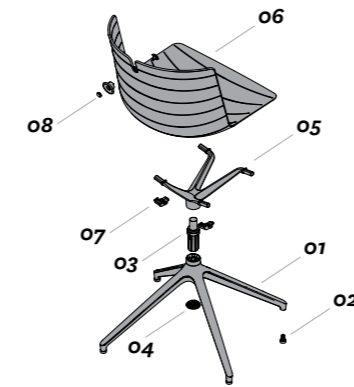

#### Opzioni movimento fisso / Fix adaptor options

##### \*\* 1x ACM267FZC

Adattatore fisso per base piramidale (con 1+2 spine). Fixed adaptor for pyramidal base (with 1+2 plugs).

#### Opzioni / Options

##### 4x PDT006

Feltro per piedino nero. Black felt

## MORK kit 221/L

Sedia in plastica su 4 gambe legno / Plastic chair on 4 wooden legs

### 01. 1x TLL150LN

Telaio 4 gambe in legno. 4 stars 4 legget wood frame.

### 02. 1x MSP054A\*\*

Scocca. Shell.

### 03. 2x ACY287\*\*

Clip posteriore per fissaggio scocche su telaio. Rear hook for shell fixing on frame.

### 04. 4x ACP286E4

Riduzione per telaio a slitta. Spacer for skid frame.

### 05. 1x CFP010A\*\*

Confezione bottone. Button kit.

### 06. 1x VTM0512BPXFB

Vite HILO s/punta testa Ø 10,5 TB + DS 5x12mm, brunita. HILO screw tip Ø 10,5 truss head 5x12mm, bronzed.

#### Opzioni carter / Carter options

##### 1x ACP301\*\*A

Carter sottoscocca per telaio in filo. Seat outer cover for wire frame.

##### 4x VTM0513BPCNR

Vite HILO testa Ø 10,5mm TB + DS 5x13mm, nera. HILO screw tip Ø 10,5mm truss head 5x13mm, black.

#### Opzioni pannello sedile / Seat panel options

##### 1x COL009A06

Pannello sedile in legno da tappezzare. Wooden seat panel to be upholstered.

##### 6x VTM0514BPBFZ

Vite TBEI M5x14mm, zincata. Screw hex recess truss head M5x14mm, zinc-plated.

#### Opzioni pannello scocca / Shell panel options

##### 1x COP010A07

Pannello scocca in plastica da tappezzare. Plastic shell panel to be upholstered.

##### 6x VTM0514BPBFZ

Vite TBEI M5x14mm, zincata. Screw hex recess truss head M5x14mm, zinc-plated.

##### 1x VTM0525BPBFB

Vite TBEI M5x25 mm, brunita. Screw hex recess truss head M5x25mm, bronzed.

##### 4x ACT321NR

Velcro per fissaggio copertina integrale tappezzata. Velcro strap to fix upholstery shell.



#### Colori / Colours



EV SANDY



ET HORIZON



EU MILKY



EW SUNSPASH



EQ PEPPERMINT



EN VIOLET



E4 ROAD



EM SNOWBALL

#### Colori bottone / Button colours



E4 ROAD



WN CLOUD



GJ BLAST BLUE

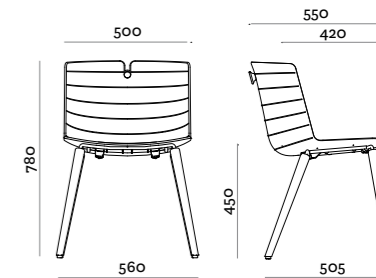
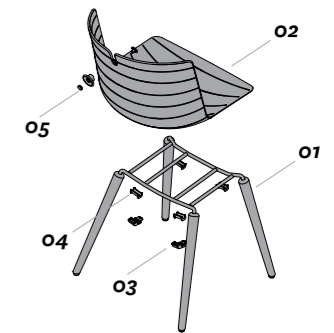

## MORK

Varianti / Variants



**MORK KIT 221/G**  
Scocca su base 4 razze piccola in alluminio c/piedini, supporto alto, girevole 360°. Shell on 4 stars small aluminium base w/glides, high seat support, 360° swivel.



**MORK KIT 221/H**  
Scocca su base 5 razze piccola in alluminio c/ruote, supporto c/leva per alzata a gas, girevole 360°. Shell on 5 stars small aluminium base w/castors, high seat support w/lever for gas lift, 360° swivel.

## MORK

Colori / Colours



**EV**  
SANDY



**E4**  
ROAD



**EN**  
VIOLET



**EU**  
MILKY



**ET**  
HORIZON



**EM**  
SNOWBALL



**EQ**  
PEPPERMINT



**EW**  
SUNSPASH

## MORK

Colori carter / Carter colours



**GH**  
SILVER



**EM**  
SNOWBALL



**E4**  
ROAD

## MORK

Colori telaio / Frame colours



**FC**  
CHROMED



**BC**  
WHITE



**E4**  
ROAD

## MORK

Colori bottone / Button colours



**E4**  
ROAD



**GJ**  
BLAST BLUE



**WN**  
CLOUD